

THIS DRAWING IS UNPUBLISHED. RELEASED FOR PUBLICATION SEPT ,2005.

© COPYRIGHT 2005 BY TYCO ELECTRONICS CORPORATION. ALL RIGHTS RESERVED.

LOC	DIST	REVISIONS					
		P	LTR	DESCRIPTION	DATE	DWN	APVD
E	B		D	ECR-05-015561	14NOV05	JMS	FWK
			E	ECR-08-022547	29AUG08	PK	PB

NOTES:

- 1. SINGLE PACK IN ACCORDANCE WITH AMP SPEC 107-3275
- 2. 100 TRAY PACK IN ACCORDANCE WITH AMP SPEC 107-3275
- 3. FLASH Au PLATING
- 4. 0.8µm Au PLATING
- 5. Ni PLATING
- 6. THIS ITEM MUST BE WHITE
- 7. HAND TOOL : 9-1478240-0
- 8. DIE SET : 9-1478242-0
- 9. ELECTRICAL CHARACTERISTICS
 FREQUENCY RANGE: DC - 2 GHz
 NOMINAL IMPEDANCE: 75 Ohm
 INSULATION RESISTANCE: 5000 MOhm
 WORKING VOLTAGE: 500 Volts RMS at Sea Level
 DIELECTRIC WITHSTAND VOLTAGE: 1500 Volts RMS Max
 CONTACT RESISTANCE:
 CENTRE CONTACT: 1.50 mOhm Max
 OUTER CONTACT: 0.20 mOhm Max
 VSWR @ 4GHz: 1.20:1 Max
 INSERTION LOSS dB @ x 3 GHz: 0.20 Max
- 10. MECHANICAL CHARACTERISTICS
 COUPLING NUT RETENTION FORCE: 445N Min
 CABLE RETENTION FORCE: 170N Min
 DURABILITY: 500 Cycles Min
- 11. ENVIRONMENTAL CHARACTERISTICS
 OPERATING TEMPERATURE: -65 to +165 DegC

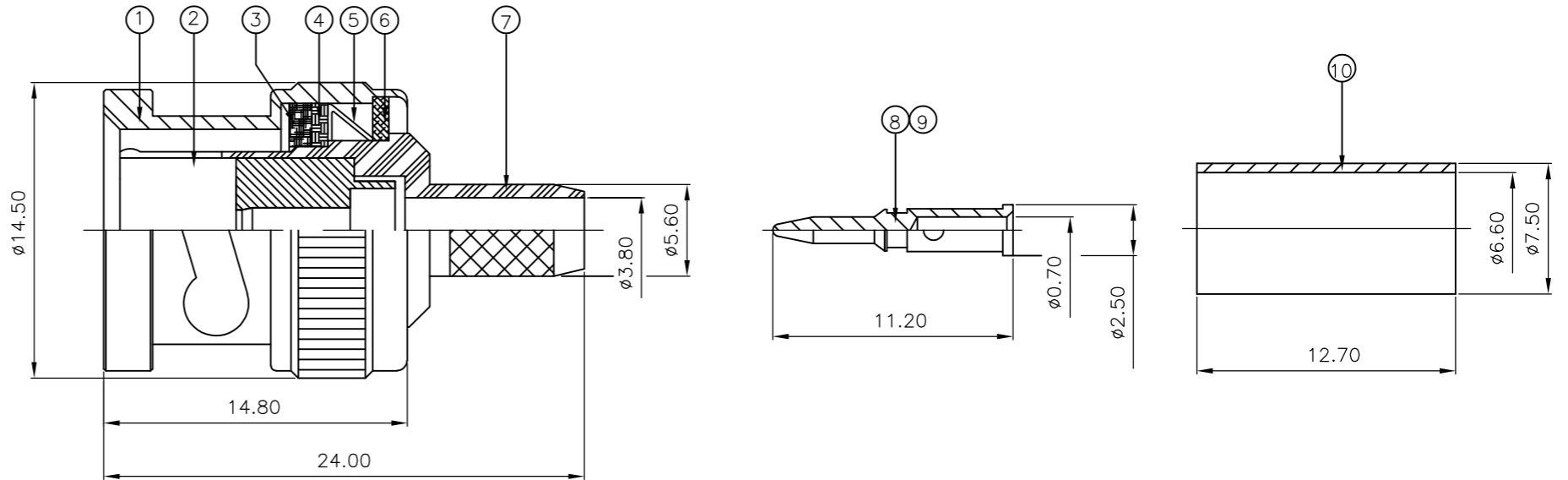

QTY	PLC	PLC	PLC	PLC	MATERIAL	DESCRIPTION	ITEM
1	1	1	1	1	BRASS	FERRULE	10
1	1	-	-	-	BRASS	CONTACT	9
-	-	1	1	1	BRASS	CONTACT	8
1	1	1	1	1	BRASS	BODY	7
1	1	1	1	1	BRASS	WASHER	6
1	1	1	1	1	SPRING STEEL	SPRING	5
1	1	1	1	1	BRASS	WASHER	4
1	1	1	1	1	SILICON RUBBER	GASKET	3
1	1	1	1	1	PTFE	INSULATION	2
1	1	1	1	1	BRASS	SHELL	1
6--1	1--1	6--0	1--0				
					MATERIAL	DESCRIPTION	ITEM
					QUANTITY PER ASSY	PARTS LIST	

THIS DRAWING IS A CONTROLLED DOCUMENT.		DWN J.SANDWELL 12SEPT05	Tyco Electronics Corporation Bideford, UK, EX39 4HE	
DIMENSIONS: mm		CHK S.PARLOW 12SEPT05		
TOLERANCES UNLESS OTHERWISE SPECIFIED:		APVD F.WHEELER-KING 12SEPT05	NAME BNC STRAIGHT PLUG CRIMP 75 OHM RG59B/U, 62A/U, 140/U, 210/U, URM90 KX6A, KX25, KX52, KX53	
0 PLC ± - 1 PLC ± - 2 PLC ± - 3 PLC ± - 4 PLC ± - ANGLES ± -		PRODUCT SPEC 108-3435	RESTRICTED TO	
MATERIAL SEE TABLE		FINISH SEE TABLE	APPLICATION SPEC 411-3247	SCALE NTS
		WEIGHT -	SIZE A3	SHEET 1 OF 2
		CUSTOMER DRAWING	DRAWING NO 1337428	REV E

LOC E	DIST B	REVISIONS			
P	LTR	DESCRIPTION	DATE	DWN	APVD
	-	SEE SHEET 1	-	-	-

ASSEMBLY INSTRUCTION

CABLES: RG59B/U

STEP 1

- 1. SLIDE METAL CRIMP FERRULE OVER CABLE

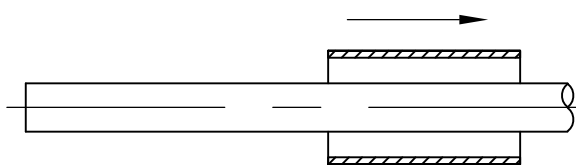

STEP 2

- 1. STRIP CABLE TO DIMENSIONS AS SHOWN

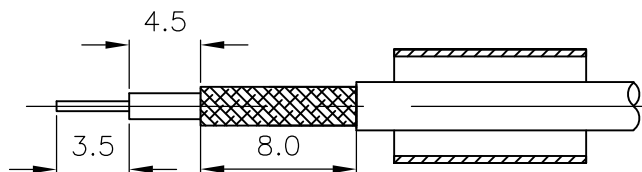

STEP 3

- 1. FIT CONTACT OVER CENTRE CONDUCTOR TO BUTT AGAINST DIELECTRIC.
- 2. CRIMP USING TOOL AS NOTES ON PAGE 1.

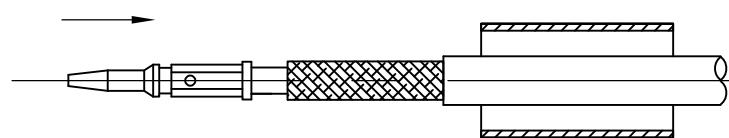

RECOMMENDED CENTRE CONTACT
A/F HEX

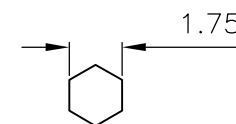

STEP 4

- 1. PRESS SUB-ASSEMBLY INTO BODY, UNTIL CONTACT IS FULLY LOCATED BY AN AUDIBLE CLICK.
- 2. ENSURE THAT KNURLED HOUSING INSERTS BETWEEN THE DIELECTRIC AND CABLE BRAID.

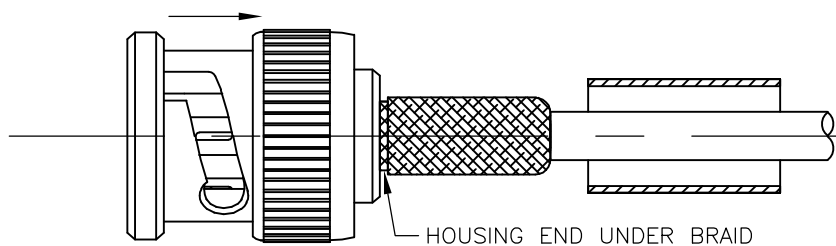

HOUSING END UNDER BRAID

STEP 5

- 1. SLIDE CRIMP FERRULE ALONG THE CABLE UNTIL IT BUTTS AGAINST THE HOUSING BODY.
- 2. CRIMP USING TOOL AS NOTED ON PAGE 1.
- 3. CRIMP DIMENSION AS SHOWN.

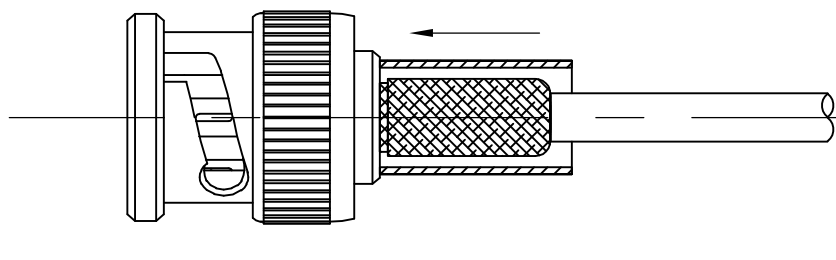

RECOMMENDED CRIMP SLEEVE
A/F HEX

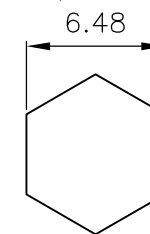

THIS DRAWING IS A CONTROLLED DOCUMENT.

DIMENSIONS:	TOLERANCES UNLESS OTHERWISE SPECIFIED:
mm	0 PLC ± -
	1 PLC ± -
	2 PLC ± -
	3 PLC ± -
	4 PLC ± -
	ANGLES ± -

MATERIAL
SEE TABLE

FINISH
SEE TABLE

DWN	J.SANDWELL	12SEPT05
CHK	S.PARLOW	12SEPT05
APVD	F.WHEELER-KING	12SEPT05
PRODUCT SPEC	108-3435	
APPLICATION SPEC	411-3247	
WEIGHT	-	

		Tyco Electronics Corporation Bideford, UK, EX39 4HE	
NAME		BNC STRAIGHT PLUG CRIMP 75 OHM RG59B/U, 62A/U, 140/U, 210/U, URM90 KX6A, KX25, KX52, KX53	
SIZE	CAGE CODE	DRAWING NO	RESTRICTED TO
A3	00779	C-1337428	-
CUSTOMER DRAWING		SCALE	SHEET 2 OF 2
		NTS	REV E