

BNX026H01#

“#” indicates a package specification code.



< List of part numbers with package codes >

BNX026H01K BNX026H01L BNX026H01B

Appearance & Shape

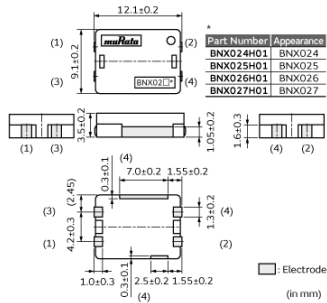

Features

BNX024H/025H/026H/027H (Block Type EMIFIL for automotive) is EMI suppression filter supporting large current, wide frequency.

And it also supports SMD mounting.

This product is effective for noise suppression for DC switching line of automotive device and FA/OA device, because it covers wide temperature range from -55C degrees to 125 C degrees.

Features

1. Supporting large current (15A)
2. Supporting wide frequency range
From 40kHz to 1GHz:35dB min.(BNX027)
3. Suitable for miniaturization with SMD shape.

Applications

Automotive Usage	Powertrain/Safety
------------------	-------------------

Applications

Automotive devices/Displays (PDP/LCD-TV)/
Digital AV equipments/Amusement equipments/
PC peripheral equipments/Industry equipments/
Measurement equipments/Power supplies

Packaging Information

Packaging	Specifications	Minimum Order Quantity
K	330mm Embossed Tape	1500
L	180mm Embossed Tape	400
B	Bulk(Bag)	100

Attention

1.This datasheet is downloaded from the website of Murata Manufacturing Co., Ltd. Therefore, it's specifications are subject to change or our products in it may be discontinued without advance notice. Please check with our sales representatives or product engineers before ordering.

2.This datasheet has only typical specifications because there is no space for detailed specifications.

Therefore, please review our product specifications or consult the approval sheet for product specifications before ordering.

BNX026H01#

“#” indicates a package specification code.

Specifications

Shape	SMD
Length	12.1mm
Length Tolerance	±0.2mm
Width	9.1mm
Width Tolerance	±0.2mm
Thickness	3.5mm
Thickness Tolerance	±0.2mm
Rated Current	20A
Operating Temperature Range	-55°C to 125°C
Mass(typ.)	0.86g
Rated Voltage	50Vdc
Withstanding Voltage	125Vdc
Insulation Resistance(min.)	10MΩ
Insertion Loss	50kHz to 1GHz:35dB min. (Line impedance=50Ω)

Attention

1.This datasheet is downloaded from the website of Murata Manufacturing Co., Ltd. Therefore, it's specifications are subject to change or our products in it may be discontinued without advance notice. Please check with our sales representatives or product engineers before ordering.

2.This datasheet has only typical specifications because there is no space for detailed specifications.

Therefore, please review our product specifications or consult the approval sheet for product specifications before ordering.

BNX026H01#

“#” indicates a package specification code.

Product Data

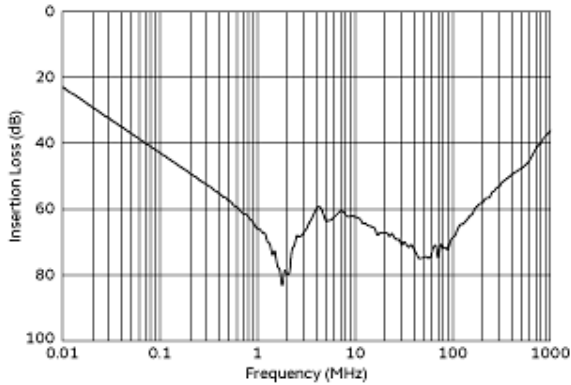

Insertion Loss Characteristics

In operating temperature exceeding +85°C, derating of current is necessary for BNX024H/025H/026H/027H series. Please apply the derating curve shown in chart according to the operating temperature.

Derating of Rated Current

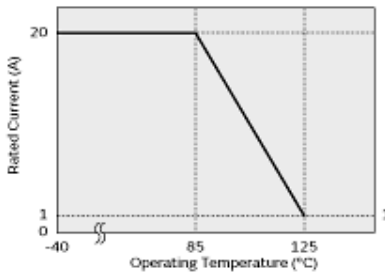

Derating of Rated Current

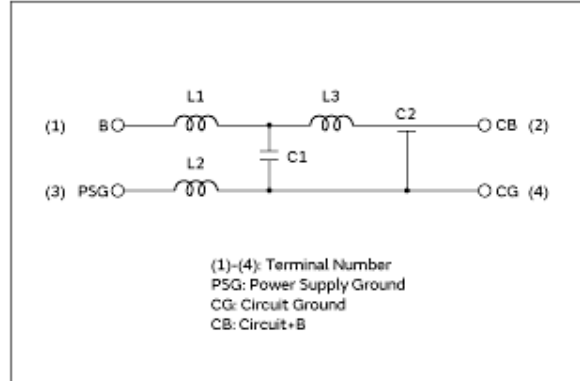

Equivalent Circuit

Attention

- 1.This datasheet is downloaded from the website of Murata Manufacturing Co., Ltd. Therefore, it's specifications are subject to change or our products in it may be discontinued without advance notice. Please check with our sales representatives or product engineers before ordering.
- 2.This datasheet has only typical specifications because there is no space for detailed specifications. Therefore, please review our product specifications or consult the approval sheet for product specifications before ordering.