



ENGLISH

Datasheet

RS Pro Grey F2000 Control Panel Trunking DIN W50XH75

RS Stock No: 136-9154

The Control Panel Trunking DIN is extrusion-made out of rigid- PVC and will be punched.

Characteristic:

Material:	rigid-PVC lead-, silicon- and cadmium-free (RoHS conform)		
Operation temperature:	static:	-20°C...+60°C (permanently)	
		-30°C...+75°C (briefly)	
working temperature:	Dynamic:	-5°C...+60°C	
Fire behaviour:	hard to inflame	DIN 4102	Level B1
	Self-extinguishing	UL94	V0
	Fire load		5,2 kWh/kg
Dielectric strength:	>30kV/mm		
UV resistance:	PVC is conditionally permanent to UV-light, changes in colour under UV-light can not be excluded		
Colour:	RAL 7030 gray		
Delivery length:	2000 mm with cover		

Special property:

- Cover contour 90°
- Ideal fit of cover, easy assembly and disassembly
- Smooth fingers – will not hurt the installer or damage the cables
- Cable hold-back noses from installation height 75 mm onwards
- Web Thickness 7,5 mm; slot width 5 mm
- Notch points at the slides and base of trunkings
- Perforated base according to DIN 50085-2-3, identical punch picture for each length
- 3- lanes hole pattern starts at width 75 mm
- Self-adhesive tape as retaining aid on the bottom of the trunking
- Attachments and more information's you will find under www.licatec.de



Datasheet

Dimension:

DIN	Height (H) mm	Width (W) mm					
	25	25					
37,5	25	37,5	50				
50	25	37,5	50	75	100		
75	25	37,5	50	75	100	125	
100			50	75	100		150

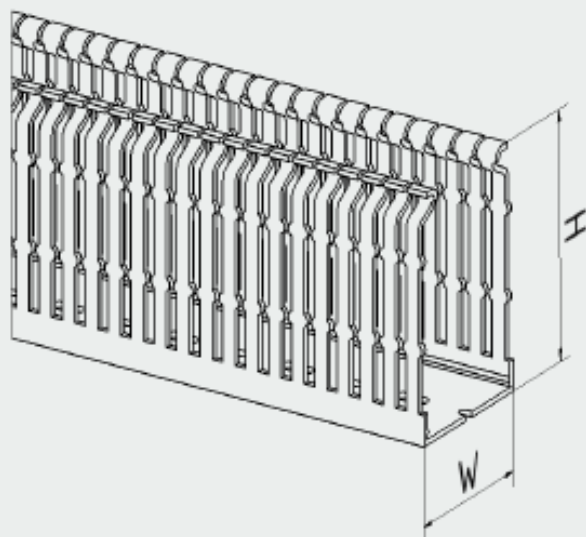

Width 75 upwards

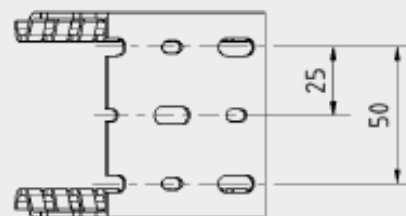

Up to width 50

